



Suprema D



Suprema D NT-S



Suprema SO

SUPREMA



- › Stopień ochrony IP54 lub IP44*
- › Elementy konstrukcyjne oprawy wykonane z wysokiej jakości materiałów: korpus z PC/ABS, klosz z PC, płyta kierunkowa z PMMA
- › Dostępne kolory obudowy: biały lub czarny
- › Napięcie zasilania: 230V AC 50Hz (dla MT, AT i CT) lub 230V AC 50Hz / 220V DC (dla CB)
- › Źródło światła: diody LED
- › Funkcje: NM – awaryjna lub M – sieciowo-awaryjna
- › Akumulatory LiFePO4 z czasami autonomii 1h, 2h lub 3h *, ładowanie 24h
- › Opcje testowania: auto test AT (możliwość ręcznego wywołania testu) lub test centralny CT (system WELLS)
- › Montaż sufitowy natynkowy lub podtynkowy, dostępne akcesoria do montażu oprawy natynkowej na ścianie, flagowo lub na zwieszakach
- › Do oświetlenia dróg ewakuacyjnych, wskazywania kierunków ewakuacji oraz oznaczania wyjść ewakuacyjnych w budynkach użyteczności publicznej
- › Widoczność: 30m
- › Zakres temperatury pracy: t_a 10°C ÷ 40°C
- › Temperatura barwowa 5000K
- › Współczynnik oddawania barw: $R_a \geq 70$
- › Minimalna żywotność źródła światła: 50 000h

* - zależnie od wersji

- › IP54 or IP44 protection rating*
- › Luminaire's housing elements made of high quality materials: PC/ABS body, PC diffuser, PMMA light guide plate
- › Housing color available: white or black
- › Supply voltage: 230V AC 50Hz (for MT, AT and CT) or 230V AC 50Hz / 220V DC (for CB)
- › Light source: LED diodes
- › Functions: NM – non-maintained version or M – maintained version
- › LiFePO4 batteries with autonomy times 1h, 2h or 3h *, charging 24h
- › Test options: auto test AT (possibility to manually call the test) or central test CT (WELLS system)
- › Ceiling installation, surface or recessed, surface version with wall, flag or pendant mounting possibility using additional accessories
- › For illuminating evacuation paths, indicating its directions and marking evacuation exits in public utility buildings
- › Visibility: 30m
- › Temperature working range: t_a 10°C ÷ 40°C
- › Colour temperature 5000K
- › CRI index: $R_a \geq 70$
- › Minimum LED lifetime: 50 000h

* - depending on version

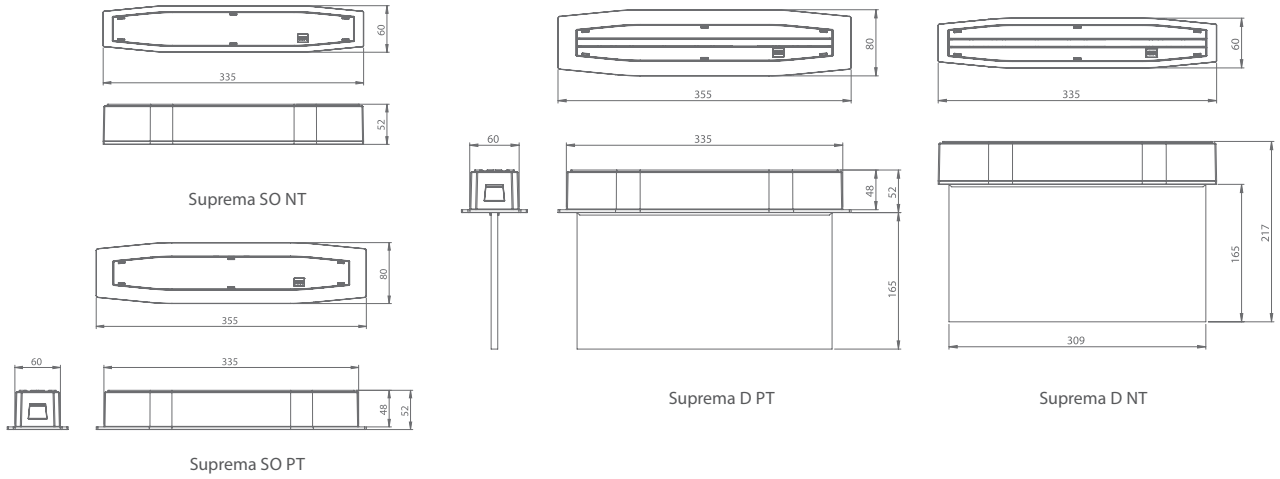
**SUPREMA SO**

Model / Model	Numer katalogowy / Catalogue number		Optyka / Optics	Strumień świetlny / Luminous flux	Tryb / Mode	Autonomia / Autonomy	Test / Test	Stopień ochrony / Protection level	Moc / Power	Akumulator / Battery Pack	
	Biały / White	Czarny / Black									
SUPREMA SO NT											
SUPREMA SO 150 M 3H AT IP54 NT	94504	93980	SO	167 lm	M	3h	AT	IP54	7W	LiFePO4 6.4V 1600mAh	
SUPREMA SO 250 M 3H AT IP54 NT	94512	93977	SO	275 lm	M	3h	AT	IP54	9W	LiFePO4 6.4V 3000mAh	
SUPREMA SO 350 M 3H AT IP54 NT	94517	93976	SO	356 lm	M	3h	AT	IP54	9W	LiFePO4 6.4V 3000mAh	
SUPREMA SO 350-P M 3H AT IP54 NT	94521	93975	SO	407 lm	M	3h	AT	IP54	9W	LiFePO4 6.4V 3000mAh	
SUPREMA SO 650 NM 2H AT IP54 NT	94519	93974	SO	636 lm	NM	2h	AT	IP54	3,5W	LiFePO4 6.4V 3000mAh	
SUPREMA SO 150 M 3H CT IP54 NT	94508	94803	SO	167 lm	M	3h	CT	IP54	7W	LiFePO4 6.4V 1600mAh	
SUPREMA SO 250 M 3H CT IP54 NT	94516	94807	SO	275 lm	M	3h	CT	IP54	9W	LiFePO4 6.4V 3000mAh	
SUPREMA SO 350 M 3H CT IP54 NT	94518	94809	SO	356 lm	M	3h	CT	IP54	9W	LiFePO4 6.4V 3000mAh	
SUPREMA SO 350-P M 3H CT IP54 NT	94522	94811	SO	407 lm	M	3h	CT	IP54	9W	LiFePO4 6.4V 3000mAh	
SUPREMA SO 650 NM 2H CT IP54 NT	94520	94812	SO	636 lm	NM	2h	CT	IP54	3,5W	LiFePO4 6.4V 3000mAh	
SUPREMA SO 150 CB IP54 NT	94550	94549	SO	167 lm	-	-	CB	IP54	4W	-	
SUPREMA SO 250 CB IP54 NT	95298	95436	SO	275 lm	-	-	CB	IP54	5W	-	
SUPREMA SO 350 CB IP54 NT	94579	94581	SO	356 lm	-	-	CB	IP54	7W	-	
SUPREMA SO 650 CB IP54 NT	94578	95499	SO	636 lm	-	-	CB	IP54	10W	-	

SUPREMA SO PT

SUPREMA SO 150 M 3H AT IP54 PT	94554	93970	SO	167 lm	M	3h	AT	IP54	7W	LiFePO4 6.4V 1600mAh
SUPREMA SO 250 M 3H AT IP54 PT	94562	93967	SO	275 lm	M	3h	AT	IP54	9W	LiFePO4 6.4V 3000mAh
SUPREMA SO 350 M 3H AT IP54 PT	94567	93966	SO	356 lm	M	3h	AT	IP54	9W	LiFePO4 6.4V 3000mAh
SUPREMA SO 350-P M 3H AT IP54 PT	94571	93965	SO	407 lm	M	3h	AT	IP54	9W	LiFePO4 6.4V 3000mAh
SUPREMA SO 650 NM 2H AT IP54 PT	94569	93963	SO	636 lm	NM	2h	AT	IP54	3,5W	LiFePO4 6.4V 3000mAh
SUPREMA SO 150 M 3H CT IP54 PT	94558	94804	SO	167 lm	M	3h	CT	IP54	7W	LiFePO4 6.4V 1600mAh
SUPREMA SO 250 M 3H CT IP54 PT	94566	94808	SO	275 lm	M	3h	CT	IP54	9W	LiFePO4 6.4V 3000mAh
SUPREMA SO 350 M 3H CT IP54 PT	94568	94810	SO	356 lm	M	3h	CT	IP54	9W	LiFePO4 6.4V 3000mAh
SUPREMA SO 350-P M 3H CT IP54 PT	94572	93964	SO	407 lm	M	3h	CT	IP54	9W	LiFePO4 6.4V 3000mAh
SUPREMA SO 650 NM 2H CT IP54 PT	94570	94813	SO	636 lm	NM	2h	CT	IP54	3,5W	LiFePO4 6.4V 3000mAh
SUPREMA SO 150 CB IP54 PT	94596	94597	SO	167 lm	-	-	CB	IP54	4W	-
SUPREMA SO 250 CB IP54 PT	94595	95434	SO	275 lm	-	-	CB	IP54	5W	-
SUPREMA SO 350 CB IP54 PT	95343	95482	SO	356 lm	-	-	CB	IP54	7W	-
SUPREMA SO 650 CB IP54 PT	95358	95497	SO	636 lm	-	-	CB	IP54	10W	-

SO - strefy otwarte / open spaces
M - tryb sieciowo-awaryjny / maintained mode
NM - tryb awaryjny / non-maintained mode
AT - test automatyczny / auto test

CT - test centralny (system WELLS) / central test (WELLS system)
CB - bateria centralna / central battery
NT - montaż sufitowy / surface mounting
PT - montaż podtynkowy / recessed mounting

Suprema SO Black
zainstalowana jako NT /
NT surface installationSuprema SO
zainstalowana jako PT /
PT recessed installation

SUPREMA SC

Model / Model	Numer katalogowy / Catalogue number		Optyka / Optics	Strumień świetlny / Luminous flux	Tryb / Mode	Autonomia / Autonomy	Test / Test	Stopień ochrony / Protection level	Moc / Power	Akumulator / Battery Pack
	Biały / White	Czarny / Black								
SUPREMA SC NT										
SUPREMA SC 150 M 3H AT IP54 NT	94702	93951	SC	169 lm	M	3h	AT	IP54	6W	LiFePO4 6.4V 1600mAh
SUPREMA SC 250 M 3H AT IP54 NT	94706	93949	SC	270 lm	M	3h	AT	IP54	9W	LiFePO4 6.4V 3000mAh
SUPREMA SC 350 M 3H AT IP54 NT	94724	88732	SC	374 lm	M	3h	AT	IP54	3,5W	LiFePO4 6.4V 3000mAh
SUPREMA SC 150 M 3H CT IP54 NT	94704	94697	SC	169 lm	M	3h	CT	IP54	6W	LiFePO4 6.4V 1600mAh
SUPREMA SC 250 M 3H CT IP54 NT	94708	94734	SC	270 lm	M	3h	CT	IP54	9W	LiFePO4 6.4V 3000mAh
SUPREMA SC 350 M 3H CT IP54 NT	94726	88736	SC	374 lm	M	3h	CT	IP54	10W	LiFePO4 6.4V 3000mAh
SUPREMA SC 150 CB IP54 NT	88526	88646	SC	169 lm	-	-	CB	IP54	4W	-
SUPREMA SC 250 CB IP54 NT	94700	94698	SC	270 lm	-	-	CB	IP54	5W	-
SUPREMA SC 350 CB IP54 NT	94737	94739	SC	374 lm	-	-	CB	IP54	7W	-
SUPREMA SC PT										
SUPREMA SC 150 M 3H AT IP54 PT	94752	93937	SC	169 lm	M	3h	AT	IP54	6W	LiFePO4 6.4V 1600mAh
SUPREMA SC 250 M 3H AT IP54 PT	94756	93935	SC	270 lm	M	3h	AT	IP54	9W	LiFePO4 6.4V 3000mAh
SUPREMA SC 350 M 3H AT IP54 PT	94744	88724	SC	374 lm	M	3h	AT	IP54	3,5W	LiFePO4 6.4V 3000mAh
SUPREMA SC 150 M 3H CT IP54 PT	94754	94731	SC	169 lm	M	3h	CT	IP54	6W	LiFePO4 6.4V 1600mAh
SUPREMA SC 250 M 3H CT IP54 PT	94758	94735	SC	270 lm	M	3h	CT	IP54	9W	LiFePO4 6.4V 3000mAh
SUPREMA SC 350 M 3H CT IP54 PT	94746	88728	SC	374 lm	M	3h	CT	IP54	10W	LiFePO4 6.4V 3000mAh
SUPREMA SC 150 CB IP54 PT	88524	88644	SC	169 lm	-	-	CB	IP54	4W	-
SUPREMA SC 250 CB IP54 PT	94748	94749	SC	270 lm	-	-	CB	IP54	5W	-
SUPREMA SC 350 CB IP54 PT	94738	94740	SC	374 lm	-	-	CB	IP54	7W	-

SC - soczewka korytarzowa / corridor lens type
 M - tryb sieciowo-awaryjny / maintained mode
 AT - test automatyczny / auto test
 CT - test centralny (system WELLS) / central test (WELLS system)

CB - bateria centralna / central battery
 NT - montaż sufitowy / surface mounting
 PT - montaż podtynkowy / recessed mounting



Suprema SC NT



Suprema SOH NT

**SUPREMA SOH**

Model / Model	Numer katalogowy / Catalogue number		Optyka / Optics	Strumień światły / Luminous flux	Tryb / Mode	Autonomia / Autonomy	Test / Test	Stopień ochrony / Protection level	Moc / Power	Akumulator / Battery Pack
	Biały / White	Czarny / Black								
SUPREMA SOH NT										
SUPREMA SOH 250 NM 3H AT IP54 NT	94523	93954	SOH	323 lm	NM	3h	AT	IP54	3W	LiFePO4 6.4V 3000mAh
SUPREMA SOH 250 NM 3H CT IP54 NT	94524	94814	SOH	323 lm	NM	3h	CT	IP54	3W	LiFePO4 6.4V 3000mAh
SUPREMA SOH 250 CB IP54 NT	88762	88827	SOH	323 lm	-	-	CB	IP54	4,5W	-
SUPREMA SOH 400 CB IP54 NT	94580	94582	SOH	506 lm	-	-	CB	IP54	6W	-
SUPREMA SOH 600 CB IP54 NT	94591	94593	SOH	628 lm	-	-	CB	IP54	9W	-
SUPREMA SOH PT										
SUPREMA SOH 250 NM 3H AT IP54 PT	94573	93941	SOH	323 lm	NM	3h	AT	IP54	3W	LiFePO4 6.4V 3000mAh
SUPREMA SOH 250 NM 3H CT IP54 PT	94574	94815	SOH	323 lm	NM	3h	CT	IP54	3W	LiFePO4 6.4V 3000mAh
SUPREMA SOH 250 CB IP54 PT	88760	88825	SOH	323 lm	-	-	CB	IP54	4,5W	-
SUPREMA SOH 400 CB IP54 PT	88784	88849	SOH	506 lm	-	-	CB	IP54	6W	-
SUPREMA SOH 600 CB IP54 PT	94592	94594	SOH	628 lm	-	-	CB	IP54	9W	-

SOH - strefy otwarte wysokie / open spaces high
 NM - tryb awaryjny / non-maintained mode
 AT - test automatyczny / auto test
 CT - test centralny (system WELLS) / central test (WELLS system)

CB - bateria centralna / central battery
 NT - montaż sufitowy / surface mounting
 PT - montaż podtynkowy / recessed mounting

SUPREMA SCH

Model / Model	Numer katalogowy / Catalogue number		Optyka / Optics	Strumień światlny / Luminous flux	Tryb / Mode	Autonomia / Autonomy	Test / Test	Stopień ochrony / Protection level	Moc / Power	Akumulator / Battery Pack
	Biały / White	Czarny / Black								
SUPREMA SCH NT										
SUPREMA SCH 350 NM 3H AT IP54 NT	94717	93948	SCH	380 lm	NM	3h	AT	IP54	3,5W	LiFePO4 6.4V 3000mAh
SUPREMA SCH 350 NM 3H CT IP54 NT	94718	94781	SCH	380 lm	NM	3h	CT	IP54	3,5W	LiFePO4 6.4V 3000mAh
SUPREMA SCH 350 CB IP54 NT	94699	94696	SCH	380 lm	-	-	CB	IP54	6W	-
SUPREMA SCH PT										
SUPREMA SCH 350 NM 3H AT IP54 PT	94767	93934	SCH	380 lm	NM	3h	AT	IP54	3,5W	LiFePO4 6.4V 3000mAh
SUPREMA SCH 350 NM 3H CT IP54 PT	94768	94782	SCH	380 lm	NM	3h	CT	IP54	3,5W	LiFePO4 6.4V 3000mAh
SUPREMA SCH 350 CB IP54 PT	95204	95227	SCH	380 lm	-	-	CB	IP54	6W	-



Suprema SQ NT



Suprema SQ PT

SUPREMA SQ

Model / Model	Numer katalogowy / Catalogue number		Optyka / Optics	Strumień światlny / Luminous flux	Tryb / Mode	Autonomia / Autonomy	Test / Test	Stopień ochrony / Protection level	Moc / Power	Akumulator / Battery Pack
	Biały / White	Czarny / Black								
SUPREMA SQ NT										
SUPREMA SQ 150 M 3H AT IP54 NT	95602	95630	SQ	189 lm	M	3h	AT	IP54	6W	LiFePO4 6.4V 1600mAh
SUPREMA SQ 250 M 3H AT IP54 NT	95606	95634	SQ	312 lm	M	3h	AT	IP54	9W	LiFePO4 6.4V 3000mAh
SUPREMA SQ 350 M 3H AT IP54 NT	95610	95638	SQ	427 lm	M	3h	AT	IP54	10W	LiFePO4 6.4V 3000mAh
SUPREMA SQ 150 M 3H CT IP54 NT	95604	95632	SQ	189 lm	M	3h	CT	IP54	6W	LiFePO4 6.4V 1600mAh
SUPREMA SQ 250 M 3H CT IP54 NT	95608	95636	SQ	312 lm	M	3h	CT	IP54	9W	LiFePO4 6.4V 3000mAh
SUPREMA SQ 350 M 3H CT IP54 NT	95612	95640	SQ	427 lm	M	3h	CT	IP54	10W	LiFePO4 6.4V 3000mAh
SUPREMA SQ 150 CB IP54 NT	95657	95665	SQ	189 lm	-	-	CB	IP54	4W	-
SUPREMA SQ 250 CB IP54 NT	95666	95658	SQ	312 lm	-	-	CB	IP54	5W	-
SUPREMA SQ 350 CB IP54 NT	95659	95667	SQ	427 lm	-	-	CB	IP54	6W	-
SUPREMA SQ 450 CB IP54 NT	95660	95668	SQ	475 lm	-	-	CB	IP54	7W	-



SUPREMA SQ PT

SUPREMA SQ 150 M 3H AT IP54 PT	95616	95644	SQ	189 lm	M	3h	AT	IP54	6W	LiFePO4 6.4V 1600mAh
SUPREMA SQ 250 M 3H AT IP54 PT	95620	95648	SQ	312 lm	M	3h	AT	IP54	9W	LiFePO4 6.4V 3000mAh
SUPREMA SQ 350 M 3H AT IP54 PT	95624	95652	SQ	427 lm	M	3h	AT	IP54	10W	LiFePO4 6.4V 3000mAh
SUPREMA SQ 150 M 3H CT IP54 PT	95618	95646	SQ	189 lm	M	3h	CT	IP54	6W	LiFePO4 6.4V 1600mAh
SUPREMA SQ 250 M 3H CT IP54 PT	95622	95650	SQ	312 lm	M	3h	CT	IP54	9W	LiFePO4 6.4V 3000mAh
SUPREMA SQ 350 M 3H CT IP54 PT	95626	95654	SQ	427 lm	M	3h	CT	IP54	10W	LiFePO4 6.4V 3000mAh
SUPREMA SQ 150 CB IP54 PT	95661	95669	SQ	189 lm	-	-	CB	IP54	4W	-
SUPREMA SQ 250 CB IP54 PT	95662	95670	SQ	312 lm	-	-	CB	IP54	5W	-
SUPREMA SQ 350 CB IP54 PT	95663	95671	SQ	427 lm	-	-	CB	IP54	6W	-
SUPREMA SQ 450 CB IP54 PT	95664	95672	SQ	475 lm	-	-	CB	IP54	7W	-

SCH - soczewka korytarzowa do wysokich pomieszczeń / corridor lens type for high spaces

SQ - niskie strefy otwarte / square beam open spaces optics

NM - tryb awaryjny / non-maintained mode

M - tryb sieciowo-awaryjny / maintained mode

AT - test automatyczny / auto test

CT - test centralny (system WELLS) / central test (WELLS system)

CB - bateria centralna / central battery

NT - montaż sufitowy / surface mounting

PT - montaż podtynkowy / recessed mounting

Suprema SP NT



Suprema SP PT



SUPREMA SP

Model / Model	Numer katalogowy / Catalogue number		Optyka / Optics	Strumień świetlny / Luminous flux	Tryb / Mode	Autonomia / Autonomy	Test / Test	Stopień ochrony / Protection level	Moc / Power	Akumulator / Battery Pack
	Biały / White	Czarny / Black								

SUPREMA SP NT

SUPREMA SP 150 M 3H AT IP54 NT	88319	88422	SP	194 lm	M	3h	AT	IP54	6W	LiFePO4 1600mAh
SUPREMA SP 250 M 3H AT IP54 NT	88370	88474	SP	314 lm	M	3h	AT	IP54	9W	LiFePO4 3000mAh
SUPREMA SP 150 M 3H CT IP54 NT	94865	88426	SP	194 lm	M	3h	CT	IP54	6W	LiFePO4 1600mAh
SUPREMA SP 250 M 3H CT IP54 NT	88374	88478	SP	314 lm	M	3h	CT	IP54	9W	LiFePO4 3000mAh
SUPREMA SP 150 CB IP54 NT	88326	88430	SP	194 lm	-	-	CB	IP54	4W	-
SUPREMA SP 250 CB IP54 NT	88378	88482	SP	314 lm	-	-	CB	IP54	5W	-
SUPREMA SP 400 CB IP54 NT	95781	95809	SP	461 lm	-	-	CB	IP54	7W	-

SUPREMA SP NT

SUPREMA SP 150 M 3H AT IP54 PT	88311	88414	SP	194 lm	M	3h	AT	IP54	6W	LiFePO4 6.4V 1600mAh
SUPREMA SP 250 M 3H AT IP54 PT	88362	88466	SP	314 lm	M	3h	AT	IP54	9W	LiFePO4 6.4V 3000mAh
SUPREMA SP 150 M 3H CT IP54 PT	88315	88418	SP	194 lm	M	3h	CT	IP54	6W	LiFePO4 6.4V 1600mAh
SUPREMA SP 250 M 3H CT IP54 PT	88366	88470	SP	314 lm	M	3h	CT	IP54	9W	LiFePO4 6.4V 3000mAh
SUPREMA SP 150 CB IP54 PT	88324	88428	SP	194 lm	-	-	CB	IP54	4W	-
SUPREMA SP 250 CB IP54 PT	88376	88480	SP	314 lm	-	-	CB	IP54	5W	-
SUPREMA SP 400 CB IP54 PT	95779	95807	SP	461 lm	-	-	CB	IP54	7W	-

SP - optyka do punktów bezpieczeństwa / optics for safety points

M - tryb sieciowo-awaryjny / maintained mode

AT - test automatyczny / auto test

CT - test centralny (system WELLS) / central test (WELLS system)

CB - bateria centralna / central battery

NT - montaż sufitowy / surface mounting



PT - montaż podtynkowy / recessed mounting

TABELA ODSTĘPÓW DLA PŁASKICH DRÓG EWAKUACYJNYCH / SPACING TABLE FOR FLAT EVACUATION ROUTES



SUPREMA SO 150

Wysokość montażu (m) / Installation height (m)				
2,5	3,3	7,8	8,2	3,4
3	3,5	8,5	8,9	3,6
4	3,6	9,4	9,8	3,7





SUPREMA SO 250

Wysokość montażu (m) / Installation height (m)				
2,5	3,9	8,7	9,4	4,0
3	4,3	9,8	10,2	4,3
4	4,6	11,4	11,4	4,6





SUPREMA SO 350

Wysokość montażu (m) / Installation height (m)				
2,5	3,9	8,3	10,4	4,4
3	4,5	9,7	11,3	4,7
4	5,1	11,8	12,6	5,2





SUPREMA SO 350-P

Wysokość montażu (m) / Installation height (m)				
2,5	4,3	9,0	10,6	4,6
3	5,0	10,5	11,8	5,0
4	5,5	13,0	13,3	5,5





SUPREMA SO 650

Wysokość montażu (m) / Installation height (m)				
2,5	4,2	9,2	12,1	5,2
3	4,9	10,4	13,2	5,6
4	6,0	13,0	15,2	6,3





SUPREMA SC 150

Wysokość montażu (m) / Installation height (m)				
2,5	1,8	5,5	17,7	8,0
3	1,4	5,1	20,2	8,7
4	1,3	4,1	23,4	7,8

SUPREMA SC 250

Wysokość montażu (m) / Installation height (m)				
2,5	2,5	7,4	18,9	8,7
3	2,3	7,4	21,7	9,8
4	1,8	6,4	26,4	11,0

SUPREMA SC 350

Wysokość montażu (m) / Installation height (m)				
2,5	3,3	8,3	19,2	9,0
3	2,9	8,8	22,3	10,3
4	2,6	8,1	27,8	12,5

SUPREMA SQ 150

Wysokość montażu (m) / Installation height (m)				
2,5	3,9	8,6	8,6	3,9
3	4,3	9,8	9,8	4,3
4	2,2	11,6	11,6	2,2

SUPREMA SQ 250

Wysokość montażu (m) / Installation height (m)				
2,5	4,2	9,0	9,0	4,2
3	4,8	10,4	10,4	4,8
4	5,7	12,9	12,9	5,7



SUPREMA SQ 350

Wysokość montażu (m) / Installation height (m)				
2,5	4,4	9,2	9,2	4,4
3	5,1	10,9	10,8	5,1
4	6,2	13,6	13,6	6,2

SUPREMA SQ 450

Wysokość montażu (m) / Installation height (m)				
2,5	4,5	9,4	9,5	4,5
3	5,1	11,0	11,0	5,2
4	6,3	13,7	13,7	6,3

SUPREMA SOH 250

Wysokość montażu (m) / Installation height (m)				
6	5,1	12,0	11,5	5,0
8	5,5	13,6	13,2	5,4
10	5,3	14,8	14,2	5,3

SUPREMA SOH 400

Wysokość montażu (m) / Installation height (m)				
6	5,8	13,1	13,3	5,8
8	6,5	15,4	15,4	6,5
10	7,0	17,1	17,0	6,9

SUPREMA SOH 600

Wysokość montażu (m) / Installation height (m)				
6	5,8	13,3	13,3	5,8
8	6,5	15,4	15,4	6,5
10	7,2	17,1	17,1	7,2

SUPREMA SCH 350

Wysokość montażu (m) / Installation height (m)				
6	1,3	4,8	25,4	11,9
8	1,4	3,6	31,9	14,5
10	1,2	3,5	37,7	16,5



Suprema D
zainstalowana jako PT-S /
recessed mounting with suspended
light guide plate PT-S



Suprema D
zainstalowana jako NT-S /
surface mounting with
suspended light guide plate NT-S

PRZYKŁADOWE ROZSYŁY ŚWIATŁA DLA SOCZEWEK / EXEMPLARY LIGHT DIVISIONS FOR LENS

SO - strefy otwarte /
open spaces

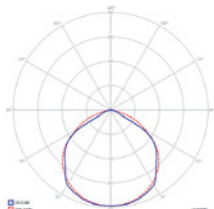

SOH - strefy otwarte wysokie /
high open spaces

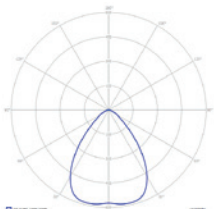

SC - korytarze /
corridors

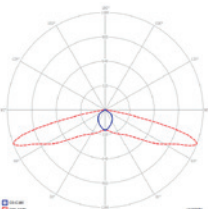

SCH - korytarze wysokie /
high corridors

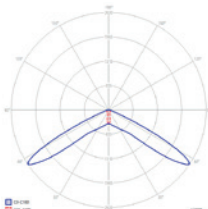

SQ - niskie strefy otwarte /
square beam open
spaces optics

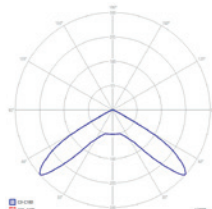

SP - do punktów
bezpieczeństwa /
for safety points

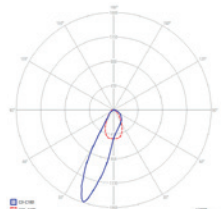



SUPREMA D



Suprema SO 150



Suprema SO 250



Suprema SO 350

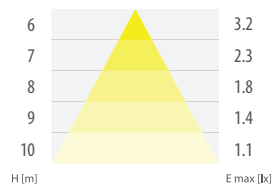

Suprema SO 350-P

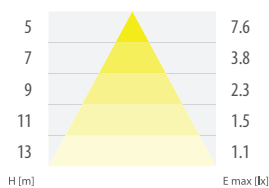

Suprema SO 650



Suprema SOH 250



Suprema SOH 400

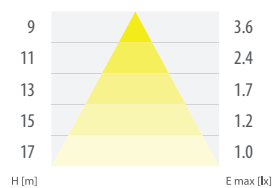

Suprema SOH 600

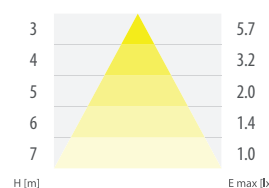

Suprema SC 150

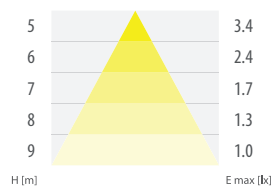

Suprema SC 250



Suprema SC 350

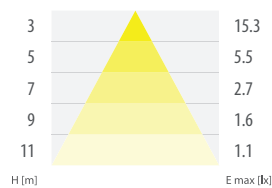

Suprema SCH 350



Suprema SQ 150



Suprema SQ 250

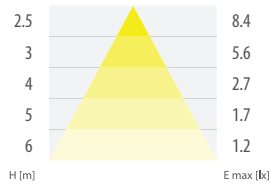

Suprema SQ 350



Suprema SQ 450



Suprema SP 150



Suprema SP 250

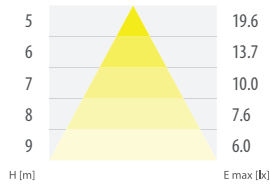

Suprema SP 400



ZESTAW / KIT



OPCJA / OPTION



Model / Model	Numer katalogowy / Catalogue number	Wymiary (mm) / Dimensions (mm)
WYJŚCIE EWAKUACYJNE LEWO / EVACUATION EXIT LEFT	85101 / E1	300 x 150
WYJŚCIE W PRAWO / EXIT TO THE RIGHT	85102 / E2	300 x 150
WYJŚCIE W LEWO / EXIT TO THE LEFT	85103 / E3	300 x 150
WYJŚCIE W LEWO W DÓŁ / EXIT DOWN TO THE LEFT	85104 / E4	300 x 150
WYJŚCIE W LEWO W GÓRĘ / EXIT UP TO THE LEFT	85105 / E5	300 x 150
WYJŚCIE W PRAWO W GÓRĘ / EXIT UP TO THE RIGHT	85106 / E6	300 x 150
WYJŚCIE W PRAWO W DÓŁ / EXIT DOWN TO THE RIGHT	85107 / E7	300 x 150
WYJŚCIE W DÓŁ PRAWO / EXIT DOWN R	85108 / E8	300 x 150
WYJŚCIE W DÓŁ LEWO / EXIT DOWN L	85109 / E9	300 x 150
WYJŚCIE W GÓRĘ PRAWO / EXIT UP R	85110 / E10	300 x 150
WYJŚCIE W GÓRĘ LEWO / EXIT UP L	85111 / E11	300 x 150
WYJŚCIE EWAKUACYJNE W LEWO / EVACUATION EXIT TO THE LEFT	85112 / E12	300 x 150
WYJŚCIE EWAKUACYJNE W PRAWO / EVACUATION EXIT TO THE RIGHT	85113 / E13	300 x 150
HYDRANT WEWNĘTRZNY / FIRE HOSE REEL	85114 / E14	300 x 150
WYJŚCIE EWAKUACYJNE PRAWO / EVACUATION EXIT RIGHT	85115 / E15	300 x 150
NEUTRALNY / NEUTRAL	85100 / E0	300 x 150

SUPREMA D

Model / Model	Numer katalogowy / Catalogue number		Tryb / Mode	Autonomia / Autonomy	Test / Test	Stopień ochrony / Protection level	Moc / Power	Akumulator / Battery Pack
	Biały / White	Czarny / Black						
SUPREMA D-std M 3H AT IP44 NT	87969	88053	M	3h	AT	IP44	6W	LiFePO4 6,4V 1600mAh
SUPREMA D-std M 3H AT IP54 NT	94604	93994	M	3h	AT	IP54	6W	LiFePO4 6,4V 1600mAh
SUPREMA D-std M 3H CT IP54 NT	94606	94670	M	3h	CT	IP54	6W	LiFePO4 6,4V 1600mAh
SUPREMA D-std M 3H AT IP44 PT	87965	88049	M	3h	AT	IP44	6W	LiFePO4 6,4V 1600mAh
SUPREMA D-std M 3H AT IP54 PT	94654	93986	M	3h	AT	IP54	6W	LiFePO4 6,4V 1600mAh
SUPREMA D-std M 3H CT IP54 PT	94656	94683	M	3h	CT	IP54	6W	LiFePO4 6,4V 1600mAh
SUPREMA D-std M 3H AT IP54 NT-S	94608	93961	M	3h	AT	IP54	6W	LiFePO4 6,4V 1600mAh
SUPREMA D-std M 3H AT IP54 PT-S	94658	93957	M	3h	AT	IP54	6W	LiFePO4 6,4V 1600mAh
SUPREMA D-std CB IP54 NT	94646	94644	-	-	CB	IP54	2,5W	-
SUPREMA D-std CB IP54 PT	94645	94635	-	-	CB	IP54	2,5W	-

D - kierunkowa płyta rozpraszająca / light guide plate

STD - wariant standardowy / standard variant

M - tryb sieciowo-awaryjny / maintained mode

AT - test automatyczny / auto test

CT - test centralny (system WELLS) / central test (WELLS system)

NT - montaż sufitowy / surface mounting

PT - montaż podtynkowy / recessed mounting

NT-S - montaż natynkowy ze zwieszoną płytą kierunkową / surface mounting with suspended light guide plate

PT-S - montaż podtynkowy ze zwieszoną płytą kierunkową / recessed mounting with suspended light guide plate

CB - bateria centralna / central battery

AKCESORIA* / ACCESSORIES*

Wykonanie produktu / Product version	Numer katalogowy / Catalogue number		
	Biały / White	Czarny / Black	Srebrny / Silver
Zestaw montażu flagowego / Flag mounting bracket	94494	93927	-
Zestaw montażu ściennego / Wall mounting bracket	94493	93926	-
Zestaw montażu zwieszanego / Suspended mounting kit	-	-	94492

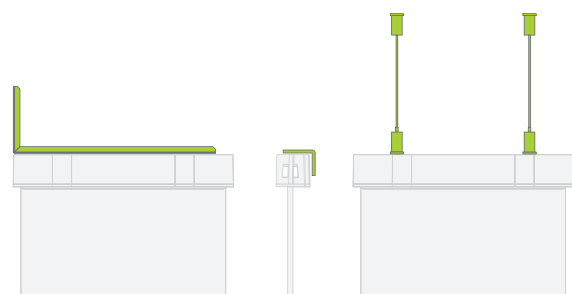

94494 / 93927

94493 / 93926

94492

*Akcesoria do modeli natynkowych (NT) / Accessories for surface-mounting models (NT)